

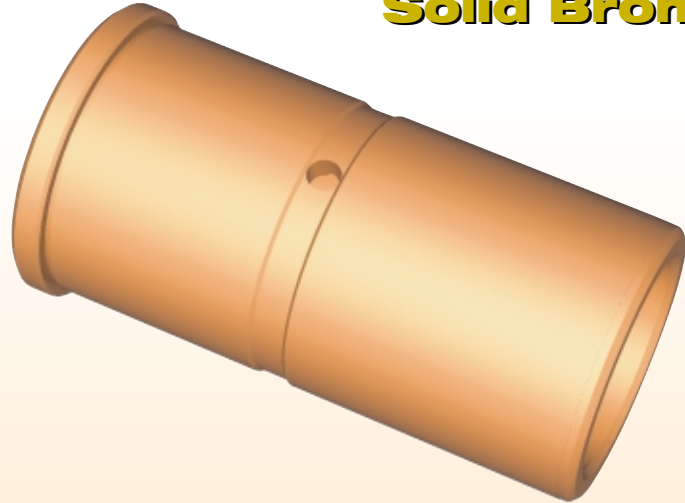

Shoulder Bushings

Solid Bronze



General Dimensions and Tolerances

Nominal I.D.	A +.0005 -.0000	B +.0005 -.0000	H +.000 -.010	T +.000 -.005
3/4	.7505	1.1255	1.250	3/16
7/8	.8755	1.2505	1.375	3/16
1"	1.0005	1.3755	1.500	3/16
1-1/4	1.2505	1.6255	1.750	3/16
1-1/2	1.5005	2.0005	2.125	3/16
2"	2.0005	2.5005	2.625	3/16

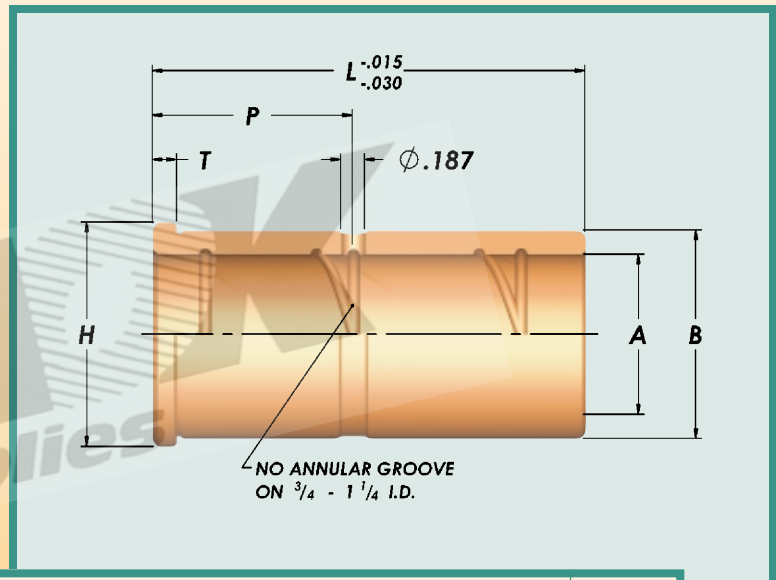

L	P	CATALOG NUMBER						L
		A=3/4"	A=7/8"	A=1"	A=1-1/4"	A=1-1/2"	A=2"	
7/8	*	2700SB	2710SB	2730SB	2750SB	2770SB		7/8
1-3/8	.56	2701SB	2711SB	2731SB	2751SB	2771SB	2901SB	1-3/8
1-7/8	.56	2702SB	2712SB	2732SB	2752SB	2772SB	2902SB	1-7/8
2-3/8	1.56	2703SB	2713SB	2733SB	2753SB	2773SB	2903SB	2-3/8
2-7/8	1.56	2704SB	2714SB	2734SB	2754SB	2774SB	2904SB	2-7/8
3-3/8	1.56	2705SB	2715SB	2735SB	2755SB	2775SB	2905SB	3-3/8
3-7/8	1.56	2706SB	2716SB	2736SB	2756SB	2776SB	2906SB	3-7/8
4-3/8	1.56	2707SB		2737SB	2757SB	2777SB	2907SB	4-3/8
4-7/8	1.56			2738SB	2758SB	2778SB	2908SB	4-7/8
5-7/8	1.56			2740SB	2760SB	2780SB	2910SB	5-7/8

* No grease groove or hole on 7/8 long bushings.